

adoremore

Connecting Living Spaces



PRODUCT CATALOGUE

uPVC FRAMES

INWARD / OUTWARD OPENING | SLIDING | SLIDING / OPENING |
ENTRANCES

TABLE OF CONTENTS

Introduction	4
Inward / Outward Opening	6
Sliding	12
Sliding / Opening	14
Entrances	16
Characteristics	20



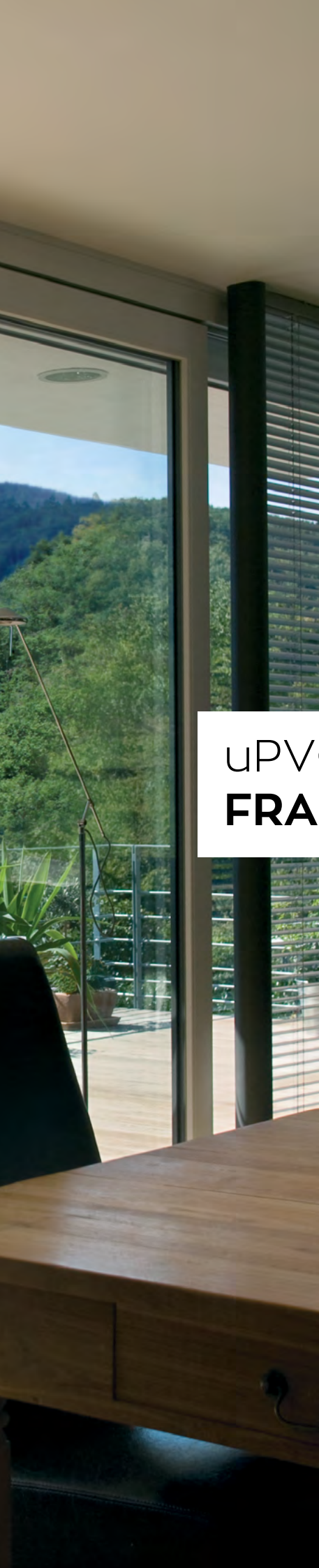

uPVC FRAMES

We manufacture integrated uPVC solutions, focusing on the certified quality of raw materials and the manufacturing and application process. We seek to offer solutions that will provide safety, protection and high energy efficiency.

The innovative design and wide choice of styles and colours allows us to offer you a wide range of specialised solutions, always driven by functionality and aesthetic quality.







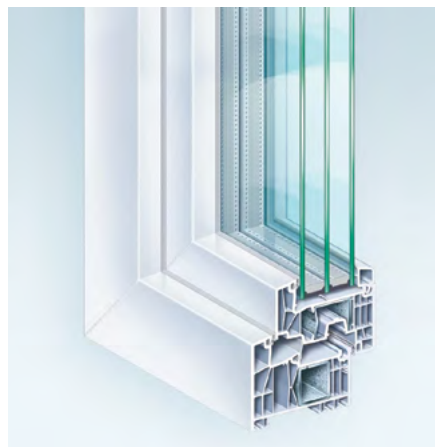

KÖMMERLING 88

High insulation window system with standard face width of 116mm.

uPVC window system KÖMMERLING 88 PLUS is the latest solution provided, featuring excellent thermal-insulation, soundproofing and sealing properties, in combination with their great burglar-resistance performance and durability.

Among their special functionality characteristics is the possibility of installing a triple glass pane and the 3 integrated PCE sealing gaskets, and the frame comes in various colours so that it can be perfectly integrated in the place where it is fitted.



-  5/5 Thermal insulation
-  5/5 Waterproofing index
-  4/5 Burglary protection
-  5/5 Soundproofing
-  4/5 Strength index





KÖMMERLING 88 (proEnergy Tec)





High insulation window system, with standard face width of 120mm.

uPVC window system KÖMMERLING 88 (proEnergy Tec) is the best solution for high thermal insulation properties, in combination with their great burglary protection, soundproofing performance and durability.

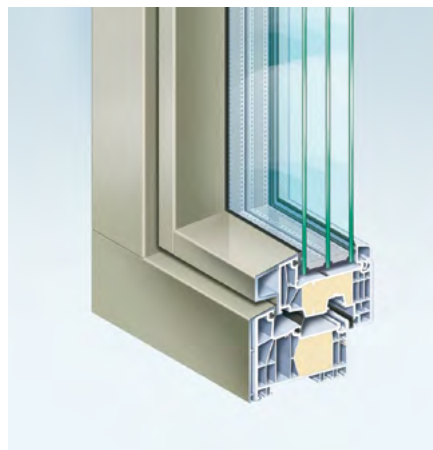
Among their special functionality characteristics is the possibility of installing a triple glass pane and the 3 integrated PCE sealing gaskets, and the frame is the ideal solution for Passive House applications.





-  5/5 Thermal insulation
-  5/5 Waterproofing index
-  4/5 Burglary protection
-  5/5 Soundproofing
-  4/5 Strength index

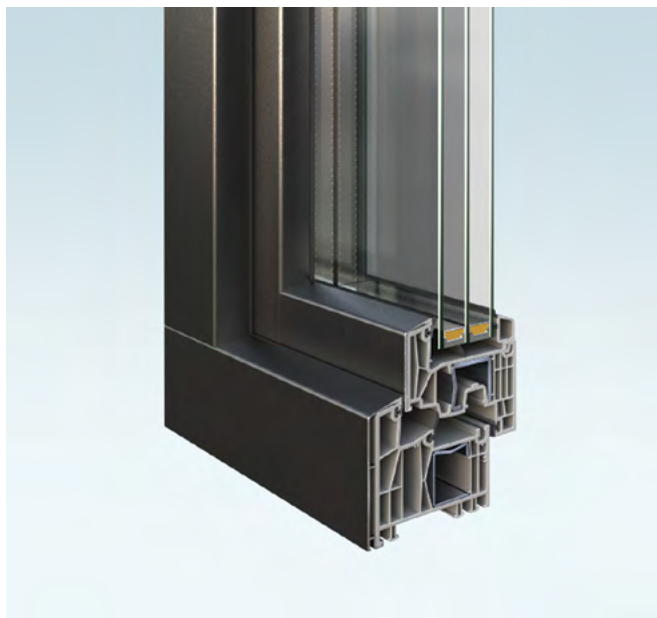

KÖMMERLING 88 ALUCLIP

High insulation window system, with standard face width of 122mm.

Among its special characteristics is the possibility of installing a triple glass pane and the 3 integrated PCE sealing gaskets, as well as the external clipped aluminum cladding; moreover, the frame comes in various colours.

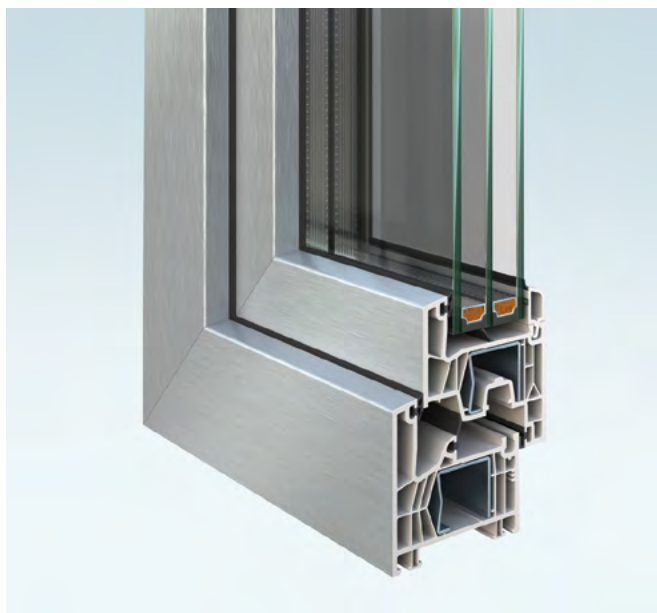

KÖMMERLING 76MD

High insulation window system, with basic face width of 116mm.

uPVC window system KÖMMERLING 76MD, with the possibility of installing a triple glass pane and the 3 integrated PCE sealing gaskets is one of the most integrated eco-friendly solutions, featuring excellent thermal-insulation and sealing properties, in combination with their great burglary protection, soundproofing performance and durability.

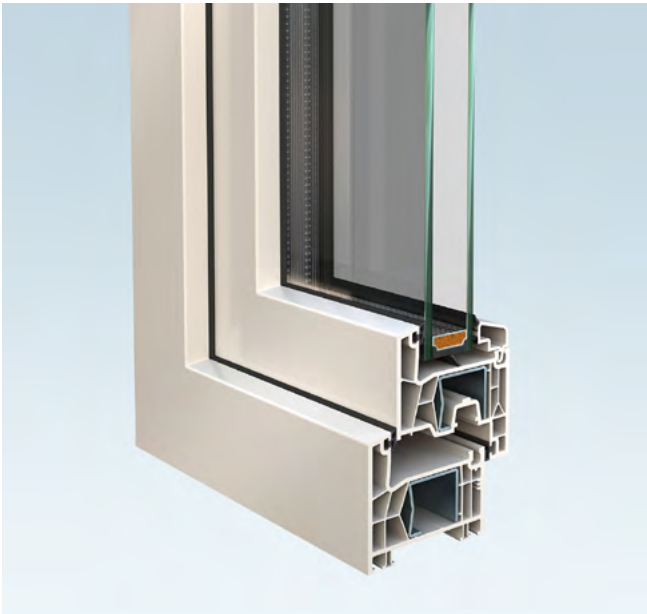

KÖMMERLING 76AD

High insulation window system, with standard face width of 116mm, with the possibility of installing a triple glass pane.

KÖMMERLING 76AD basic thermal-insulation and waterproofing features complete its eco-friendly nature. The two integrated sealing gaskets on the casement and the sheet ensure the result of their features, while its enhanced burglary protection performance, its soundproofing performance and its functional strength complement the functional features of the frame. As far as aesthetic design is concerned, the frame comes in various colours.



KBE 70 ECONOMY

Window systems for excellent thermal insulation, basic face width of 70 mm.

The uPVC French door system KBE 70 Economy is an economic solution, without compromising at all the quality and credibility of the final product.





KÖMMERLING
PREMILINE PLINTH ALU

Sliding system, with double rails and aluminum plinth. Total face frame width is 137mm, while running is performed on INOX rails.

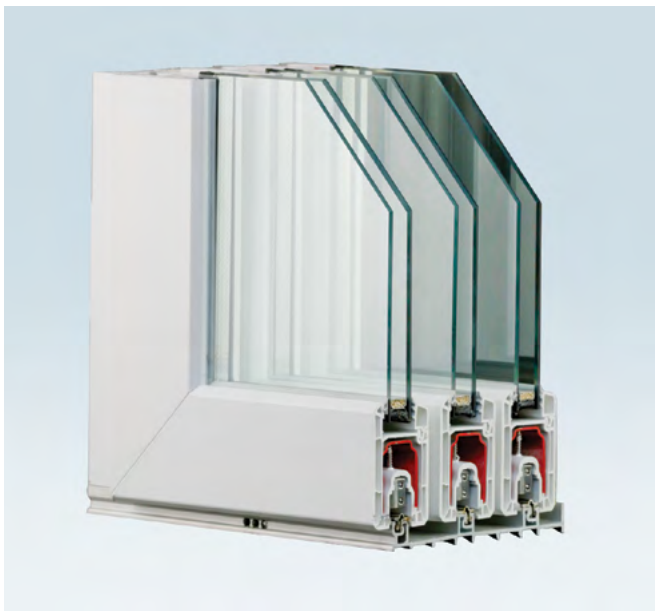

KÖMMERLING
PREMILINE TRIPLE GUIDE RAIL
ALU PLINTH

Sliding system, with triple rails and aluminum plinth. Total face frame width is 137mm, while running is performed on INOX rails.

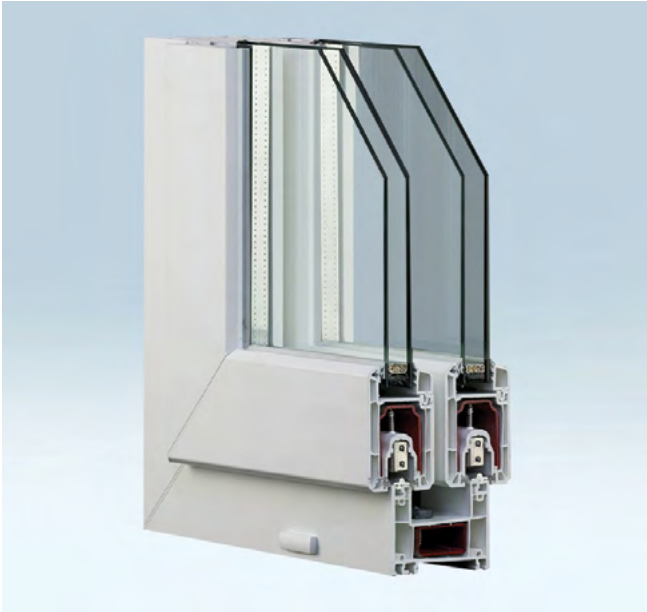

KÖMMERLING PREMILINE

Sliding system, with double rails. Total face frame width is 137mm, while running is performed on ALU rails.

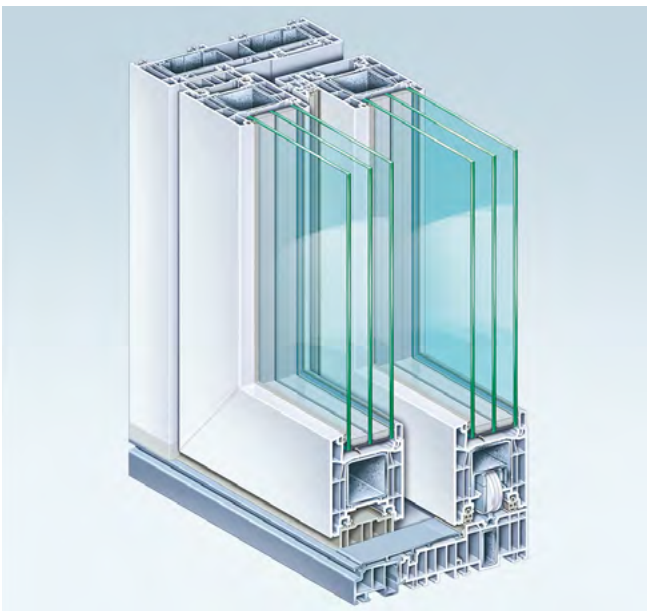

KÖMMERLING PREMIDOOR 76

Lift/Sliding System for excellent thermal insulation with standard face width of 137mm. Integrated eco-friendly solutions, featuring excellent thermal-insulation and sealing properties, complemented by the possibility of installing a triple glass pane and the excellent soundproofing performance and durability.

The option provided to install the 50mm casement on the ground makes this system even more practical; the casement comes in various colours.



KÖMMERLING
76AD PASK/VW 200KG

With excellent waterproofing performance, thermal-insulation and burglary protection, the PVC sliding/lifting frame for windows and French door system KÖMMERLING 76AD 200KG, with total face width of 166mm, is a solution with exceptional durability in time and use.

The aesthetic design of the frame is enhanced by the choice from a wide range of colours to find the best for you.





KÖMMERLING 76AD PASK/VW 150KG

With total face width of 134mm, the sliding and opening uPVC window and French door system KÖMMERLING 76AD 150KG is suitable for enhanced applications that require the combination of thermal insulation, waterproofing features, durability and security.

Still, KÖMMERLING 76AD 150KG goes further beyond that. You can adapt it to the aesthetic needs of your space thanks to the wide range of the available colours.











KÖMMERLING 76AD ALUCLIP ZERO RESIDENTIAL DOOR

High insulation main entrance door system.

The casement comes in various colours for its external side, while the smart connection technology on the outside, featuring zero depth difference (coplanar) offers a great aesthetic result.





-  ^{5/5} Thermal insulation
 -  ^{4/5} Waterproofing index
 -  ^{4/5} Burglary protection
 -  ^{5/5} Soundproofing
 -  ^{5/5} Strength index
 -  Coplanar panel
-

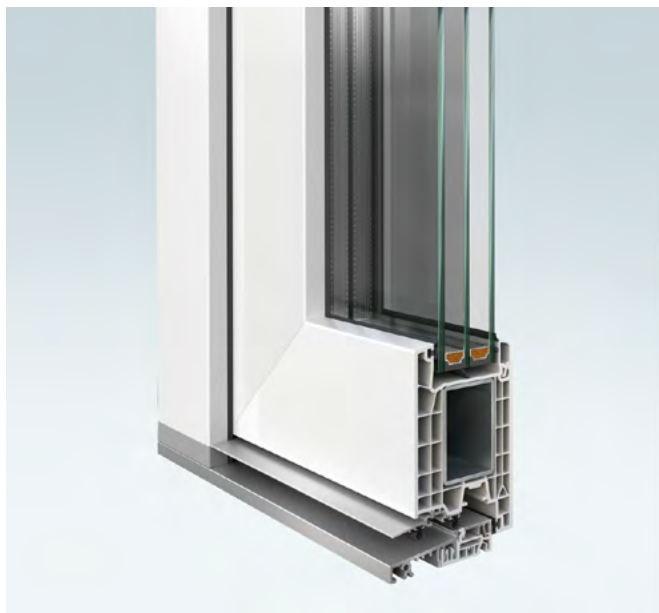

KÖMMERLING
**76AD RESIDENTIAL DOOR
(Entrance)**

High insulation door system with total face width of 148mm.



KÖMMERLING
**76AD Plus RESIDENTIAL DOOR
(Main Entrance)**

High insulation main entrance door system, with total face width of 182mm.

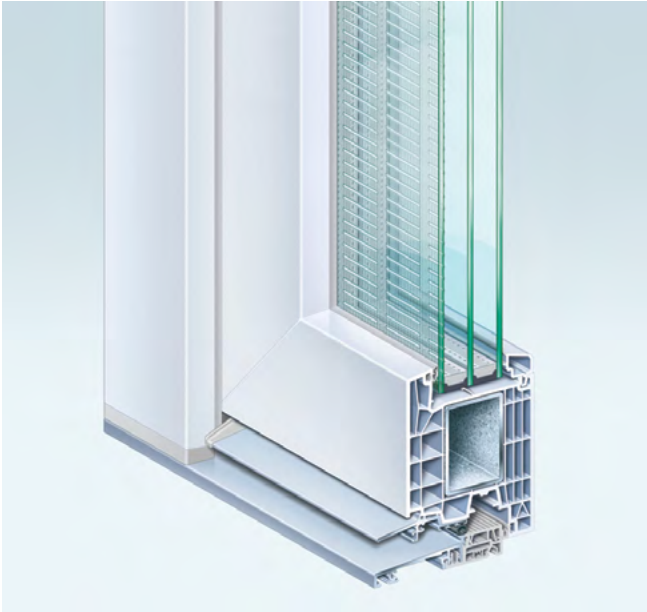

KÖMMERLING 88 RESIDENTIAL DOOR

High insulation main entrance door system, with total face width of 172 mm.



KÖMMERLING 76AD FOLDING SYSTEM

High insulation bifold door system, with total face width of 148mm on the left-right.

This frame offers the option of installing the 50mm casement on the ground, thus increasing its functionality and its walkability.









CHARACTERISTICS OF **uPVC FRAMES**





TABLE OF CHARACTERISTICS uPVC FRAMES

		 Thermal insulation	 Waterproofing index	 Burglary protection	 Soundproofing	 Strength index
INWARD/OUTWARD OPENING	KÖMMERLING 88 (ProEnergy Tec)	5/5	5/5	4/5	5/5	4/5
	KÖMMERLING 88 ALUCLIP	5/5	5/5	4/5	5/5	4/5
	KÖMMERLING 88	5/5	5/5	4/5	5/5	4/5
	KÖMMERLING 76MD	4/5	5/5	4/5	4/5	4/5
	KÖMMERLING 76AD	4/5	4/5	4/5	4/5	4/5
	KBE 70 ECONOMY	4/5	4/5	3/5	4/5	4/5
SLIDING	PREMILINE PLINTH ALU	3/5	3/5	3/5	3/5	3/5
	PREMILINE TRIPLE GUIDE RAIL ALU PLINTH	3/5	3/5	3/5	3/5	3/5
	PREMILINE	3/5	3/5	3/5	3/5	3/5
	PREMIDOOR 76 (lifting/sliding)	4/5	4/5	3/5	3/5	4/5
PASK / VW	76AD 200KG	4/5	4/5	4/5	4/5	4/5
	76AD 150KG	4/5	4/5	4/5	4/5	4/5
ENTRANCES	76AD RESIDENTIAL DOOR (Entrance)	4/5	4/5	4/5	4/5	4/5
	76AD Plus RESIDENTIAL DOOR (Main Entrance)	4/5	4/5	4/5	4/5	4/5
	76AD ALUCLIP ZERO RESIDENTIAL DOOR	5/5	4/5	4/5	5/5	5/5
	88 RESIDENTIAL DOOR	5/5	4/5	4/5	5/5	5/5
	76AD Folding System	4/5	4/5	4/5	4/5	4/5



COLOUR RANGE uPVC FRAMES







		White	Golden oak 032	Nussbaum 052	Anthracite grey 016	Dark green (Dunkelgrün) 058	Grey 021	Cremeweiß 167	Metbrush silver	Brilliant blue 085
INWARD/OUTWARD OPENING	KÖMMERLING 88 * (ProEnergy Tec)	✓								
	KÖMMERLING 88 AluClip *	✓								
	KÖMMERLING 88	✓	✓	✓	✓					
	KÖMMERLING 76MD	✓	✓	✓	✓	✓	✓	✓	✓	✓
	KÖMMERLING 76AD	✓	✓	✓	✓	✓	✓	✓	✓	✓
	KBE 70 ECONOMY	✓	✓	✓						
SLIDING	PREMILINE PLINTH ALU	✓	✓	✓	✓	✓		✓	✓	
	PREMILINE TRIPLE GUIDE RAIL ALU PLINTH	✓	✓	✓	✓	✓		✓	✓	
	PREMILINE	✓	✓	✓	✓	✓		✓	✓	
	PREMIDOOR 76 (lifting/sliding)	✓	✓	✓	✓	✓	✓	✓	✓	
PASK / VW	76AD 200KG	✓	✓	✓	✓	✓	✓	✓	✓	✓
	76AD 150KG	✓	✓	✓	✓	✓	✓	✓	✓	✓
ENTRANCES	76AD RESIDENTIAL DOOR (Entrance)	✓	✓	✓	✓	✓	✓	✓	✓	✓
	76AD Plus RESIDENTIAL DOOR (Main Entrance)	✓	✓	✓	✓	✓	✓	✓	✓	✓
	76AD AluClip RESIDENTIAL DOOR Zero *	✓								
	88 RESIDENTIAL DOOR	✓	✓	✓	✓					
	76AD Folding System	✓	✓	✓	✓	✓	✓	✓	✓	✓

* All possible aluminum shades to choose from for the external side

Colours may be a bit different, due to printing.

COLOUR RANGE FOR uPVC SYSTEMS ACCESSORIES

The table shows the colours that are available for the accessories, depending on the frame's colour.

uPVC SYSTEM COLOUR		SUPERJACENT THERMALLY INSULATED uPVC BOXES	EXTERNAL ALUMINIUM BOXES	ROLLER SHUTTER SLATS	FRAME HANDLES	INSECT SCREENS	CRANK	SNUFFBOX
 White	White	White	9016 White	040	White	9016 White	White	White
 Golden oak 032	Golden oak 032	Golden Oak 032	Golden Oak	026A	Brown	Golden Oak	Brown	Brown
 Nussbaum 052	Nussbaum 052	Nussbaum 052	Nussbaum	052	Brown	Nussbaum	Brown	Brown
 Anthracite grey 016	Anthracite grey 016	Anthracite grey 016	Ral 7016	Ral 7016	Grey	Ral 7016	Brown	Light grey
 Dark green (Dunkelgrün) 058	Dark green (Dunkelgrün) 058	Dark green (Dunkelgrün) 058	Ral 6009	Ral 6009	Green	Ral 6009	Brown	Brown
 Grey 021	Grey 021	Grey 021	Ral 7001	032	Silver	Ral 7001	White	Light grey
 Cremeweiß 167	Cremeweiß 167	Cremeweiß 167	Ral 1013	Ral 1013	Beige	Ral 1013	White	White
 Metbrush silver	Metbrush silver	Metbrush silver	Ral 9006	Ral 9006	Silver	Ral 9006	White	Light grey
 Brilliant blue 085	Brilliant blue 085	Brilliant blue 085	Ral 5007	RAL 5007 only in K19	Silver	Ral 5007	White	Light grey



DETAILED COLOUR RANGE

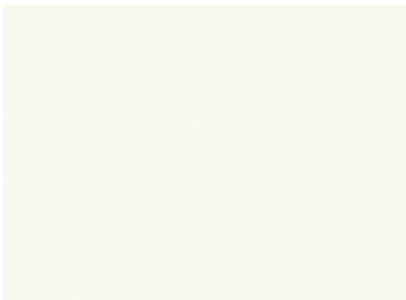

White



Golden oak 032

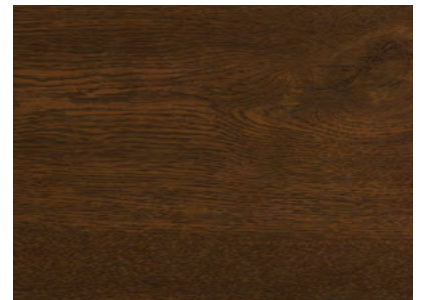

Nussbaum 052



Anthracite grey 016

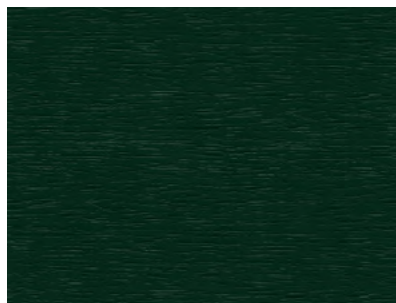

Dark green (Dunkelgrün) 058



Grey 021

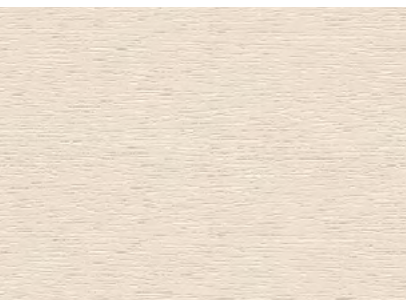

Cremeweiß 167



Metbrush silver

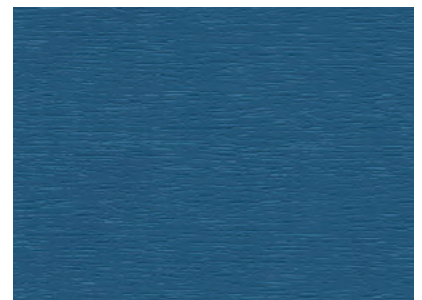

Brilliant blue



Connecting Living Spaces

Triq id-Difiza Civili,
Mosta,
MST 1743
Malta

Telephone: +356 21456570
Email: sales@adoremore.eu
Website: www.adoremore.com.mt